

NEW PRODUCT



One-stop Solution for Home Desk

Website: [Fenmicasa.com](https://fenmicasa.com)

FENMICASA

Furniture has created a new stylistic language, a fresh visual and atmospheric approach to interiors. Our intent is to design and execute new projects with surprise, creativity, precision, and vitality. Our passion for products constantly drives us to explore further. The research behind our brand's new collection marks another significant evolutionary step for FENMICASA Furniture, adopting a new decorative code of Italian minimalism. A fresh vision for office spaces is realized through systems that articulate seating and decorative elements. Alternating curves and lines reveal new geometric forms, delivering unexpected solutions for diverse environments.





efficient, and aesthetically pleasing workspace for you. The design drawing at the bottom right corner showcases its precise dimensions and structure.

•This desk is crafted from high-quality walnut wood and tempered glass, featuring a sleek and elegant design that aims to create a comfortable,

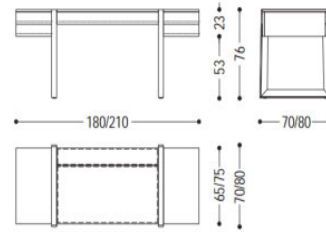



- A bold sculptural design with fluid curves and Z-shaped legs, available in walnut wood and sleek black finishes. Perfect for modern offices and home studies.

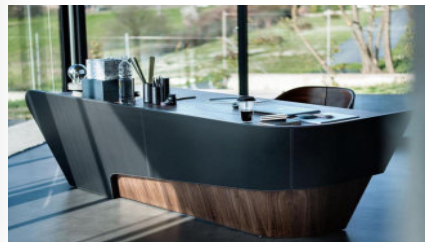
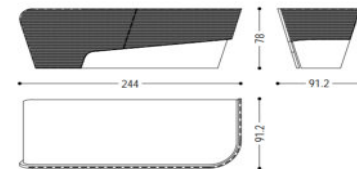

•A testament to clean lines and structured design, this collection features an architectural aesthetic with geometric shapes that convey stability and modernity.



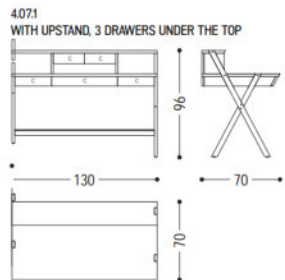

Sturdy X-Frame Design: Exceptional stability and classic aesthetics.

Integrated Storage: Built-in hutch for organized workspace.

Premium Wood Craft: Warmth and character for any room.



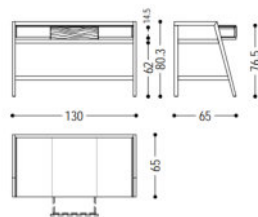

This collection blends natural walnut wood with premium leather, creating a timeless workspace that reflects refined taste and meticulous craftsmanship.





This collection blends natural walnut wood with premium leather, creating a timeless workspace that reflects refined taste and meticulous craftsmanship.





- Premium solid wood tabletop paired with sturdy metal frame, creating an elegant dialogue between warm and cool textures.
- Robust construction, suitable for a variety of modern office and home environments.



- Exquisitely minimalist design, defining spatial aesthetics with pure lines.



- Clean lines and layered design define this collection, offering subtle storage solutions without compromising on aesthetics.
- The dual-tier bench provides versatile display space, while the streamlined desk integrates functional drawers seamlessly.
- Both pieces share a commitment to minimalist principles, using high-quality materials to create enduring, contemporary forms.



B&B Italia Desk-Quiet Lines Bench





- Natural wood surfaces combined with slender metal frame.
- Flexible modular system with endless configurations.





- Integrated L-shaped configuration optimizes corner space, offering expansive work surfaces and ample storage in one cohesive unit.
- Sleek, monolithic form with a deep black finish exudes executive presence and modern luxury, suitable for high-end office environments.

- Textured panel detailing on cabinet doors adds a sophisticated tactile dimension and visual interest to the monochromatic design.



FENMI CASA Integrated L-Shaped Executive Desk

Baxter-Office Desk-PRESIDENT WRITING-DESK



- A curated collection blending premium materials: rich wood veneers, luxurious leather, and sleek matte finishes for diverse aesthetic expressions.
- Intricate textured detailing on storage panels adds depth and a sophisticated tactile quality to the clean, sculptural forms of each piece.
- Designed to command attention, balancing expansive ergonomic workspace with elegant, integrated storage solutions for high-end offices.



- A masterpiece of sculptural design, this executive desk seamlessly integrates rich wood veneer, high-gloss black lacquer, and a polished stone/metal composite base.
- Fluid, organic forms are juxtaposed with sharp geometric cuts, creating a dynamic visual tension that commands attention in any executive office.
- Beyond its artistic appeal, the desk offers a spacious, ergonomic work surface, embodying the perfect synergy between high design and functional luxury.





●A bold statement of monolithic design, this executive desk is forged from a single sculptural form in a sophisticated matte black finish, exuding power and modern elegance.



●Seamless, fluid lines are defined by sharp geometric edges, creating a dynamic yet cohesive aesthetic that commands attention in any contemporary office space.



●The meticulously finished surface, highlighted by integrated detailing, reflects an uncompromising commitment to luxury, craftsmanship, and functional artistry.



- A sophisticated fusion of natural wood grain and high-gloss black lacquer, creating a dramatic textural contrast that defines executive luxury.
- The meticulous craftsmanship highlights the beauty of natural materials, elevating the executive workspace with unparalleled luxury and design integrity.



- Sculpted from a single, seamless form, its powerful lines and integrated structure create a commanding yet sophisticated presence.

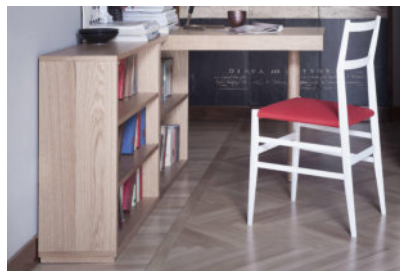

- Highly customizable modular system crafted from premium solid wood, offering endless configurations to suit diverse spatial requirements.
- Seamlessly integrates workspace, display, and storage solutions within a cohesive design, maximizing both functionality and visual appeal.
- Natural wood grain and meticulous joinery highlight exceptional craftsmanship, creating a warm, inviting atmosphere.

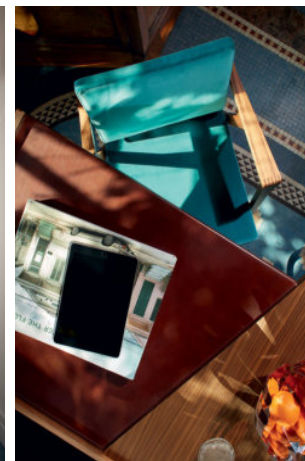
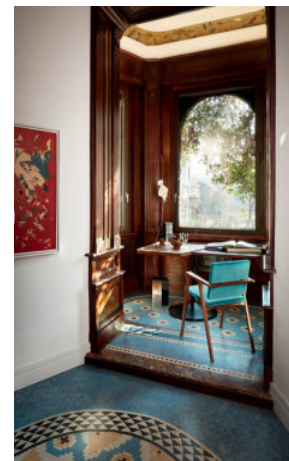

- Modular geometric design offers unparalleled flexibility in configuring your ideal workspace.
- Crafted from premium solid wood with contrasting matte lacquer and leather finishes.
- Minimalist single-stem support ensures a light, airy aesthetic for contemporary interiors.

F FENMI CASA Segmented Wood Desk System

Cassina-Office Desk-
VENTAGLIO



- An innovative desk system featuring geometric segmented wood panels, meticulously joined to create an organic, dynamic, and uniquely sculptural tabletop.

- Crafted from premium solid wood, each piece showcases exceptional joinery and a celebration of natural wood grain, offering both visual warmth and structural integrity.

- The minimalist cylindrical legs provide a light, airy counterpoint to the complex tabletop, ensuring the design remains elegant and adaptable to diverse interior spaces.



F FENMI CASA Segmented Wood Desk System

Cassina-Office Desk-
VENTAGLIO



- Distinctive organic shape handcrafted for a unique sculptural presence.
- Deep black stain on solid wood with minimalist cylindrical supports for refined elegance.

FENMI CASA Minimalist Walnut Executive Desk

CECCOTTI COLLEZIONI-Office Desk-Arturo

- Exquisitely crafted from premium walnut with clean lines.
- Integrated soft-close drawer with organized interior storage.
- Versatile centerpiece for high-end minimalist interiors.



F FENMI CASA Elegant Curved Executive Desk

CECCOTTI COLLEZIONI-Office Desk-
Bean



- A masterpiece of organic design, this executive desk features a sweeping curved silhouette crafted from premium solid wood, embodying timeless elegance.
- Integrated with multiple soft-close drawers and a central leather writing surface, it seamlessly combines luxurious aesthetics with practical storage.
- Designed to make a statement in the most discerning interiors, from contemporary lofts to classic studies, elevating any executive workspace.

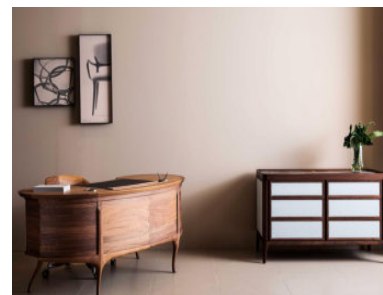



- This collection reimagines the iconic curved desk within a sophisticated monochrome palette, creating a powerful visual dialogue between organic form and minimalist aesthetics.
- From urban lofts to lakeside retreats, the design transcends setting, offering a functional yet artistic centerpiece that defines sophisticated executive style.



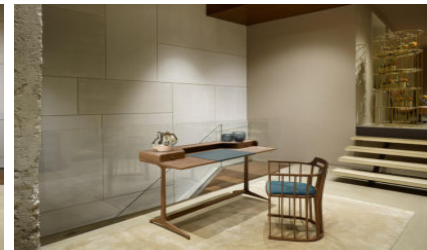
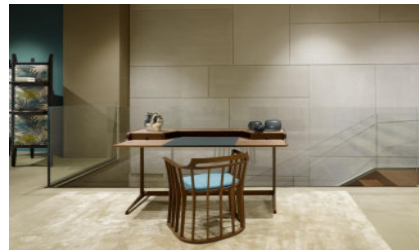

- This desk embodies refined minimalism, featuring a sophisticated combination of dark-stained solid wood and slender metal legs for a clean, contemporary aesthetic.
- Integrated with discreet, push-to-open drawers and an optional leather writing pad, it offers elegant organization and enhanced user comfort.
- Perfectly suited for both high-end offices and sophisticated home workspaces, it delivers understated luxury and functional beauty in equal measure.



• This collection epitomizes versatile elegance, designed to seamlessly integrate into a diverse range of high-end interiors, from minimalist modern to industrial chic.

• Thoughtfully integrated storage solutions, including discreet drawers and organized surface compartments, ensure both aesthetic harmony and practical functionality.





- Crafted from premium dark-stained solid wood, this desk embodies timeless authority, delivering a commanding presence in any C-suite environment.



- Featuring an extendable L-shaped configuration and soft-close drawers, it provides ultimate organizational efficiency for the modern executive.

- An optional leather writing surface adds refined luxury and comfort, elevating this desk to the pinnacle of executive workspace design.

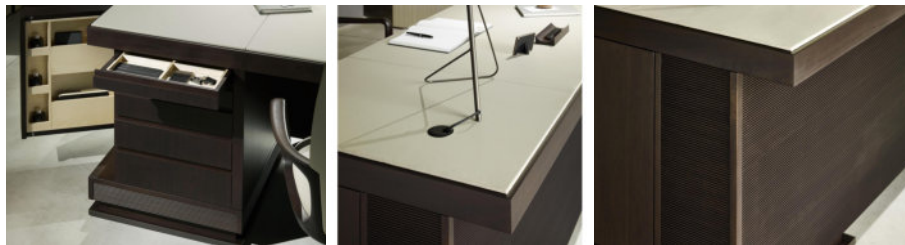



•This innovative desk masterfully combines rich walnut wood with a transparent glass top, creating a strikingly light and airy aesthetic that defies conventional design.

•The organically shaped glass surface flows seamlessly with the sculptural wooden supports, embodying a harmonious blend of modern artistry and functional design.





•Distinctive vertical fluted detailing adorns storage units, combining aesthetic appeal with ample organization.

•Sophisticated contrast between dark leather top and light-stained wood creates a timelessly elegant aesthetic.

•Graceful curved silhouette crafted from premium solid wood, offering an expansive and ergonomic workspace.

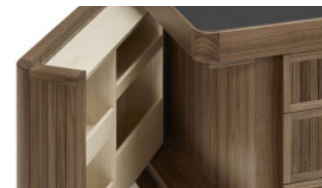

FENMI CASA Light Walnut Executive Desk

CECCOTTI COLLEZIONI-Office Desk-Paperweight



- This executive desk showcases the natural beauty of light walnut wood, featuring clean, minimalist lines that bring a sense of calm and order to any workspace.
- Ample soft-close drawers on both sides provide generous, organized storage, keeping your essentials within easy reach while maintaining a clutter-free aesthetic.
- The versatile design effortlessly complements a range of interior styles, from contemporary lofts to more traditionally appointed executive offices.





- This executive desk embodies modern sophistication with its rich, dark walnut finish and clean, architectural lines, making a bold statement in any contemporary workspace.
- Thoughtfully integrated features, such as a discreet cable management port and soft-close drawers with contrasting interiors, prioritize both aesthetics and user-centric functionality.
- The design's inherent versatility allows it to harmonize beautifully with industrial-chic concrete interiors, as well as other modern and minimalist design schemes.

FENMI CASA Metal Frame Slim Desk

CECCOTTI COLLEZIONI-Office Desk-Sopwith 165



- This slim desk features an exquisitely crafted metal frame, embodying a minimalist industrial aesthetic with clean lines and a lightweight profile.
- Available in a curated selection of tabletop finishes, including warm brown and cool blue, it offers versatile styling options to complement diverse interior schemes.
- The harmonious balance between the ultra-slim tabletop and the robust metal support structure delivers both visual elegance and reliable stability.



•Redefines workspace design with its signature fluid, lift-top white surface, merging sculptural artistry with practical concealed storage.



•Crafted from premium solid wood, the ultra-slim frame exemplifies masterful joinery, delivering an airy, weightless aesthetic.

•An icon of contemporary design, it serves as a stunning centerpiece, effortlessly enhancing minimalist, industrial, and luxurious modern interiors.



- Bold geometric design combining sleek metal frames with tempered glass tops for a modern aesthetic.
- Available in rectangular and square configurations, offering versatile solutions for contemporary spaces.
- Cohesive design DNA with interlocking circular forms for a modular and coordinated look.

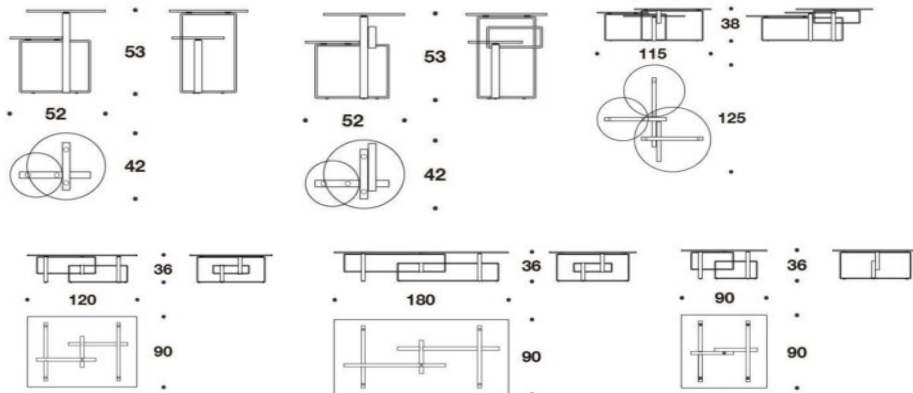



- Features premium marble tabletops with unique natural veining and elegant gold-finished metal bases.

- Available in various circular and rectangular sizes, adapting to diverse high-end environments.

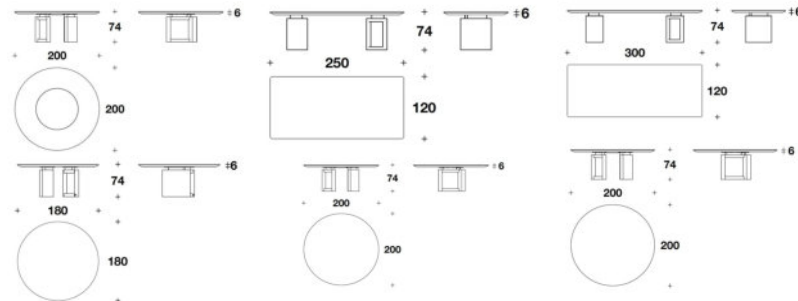



- Exquisite beige & brown leather with a luxurious gold frame, exuding modern elegance and sophisticated charm.
- Equipped with an adjustable high-definition mirror, seamlessly transitioning between a vanity and a stylish workspace.
- Integrated open shelving provides elegant and practical storage, enhancing spatial organization with a sleek aesthetic.

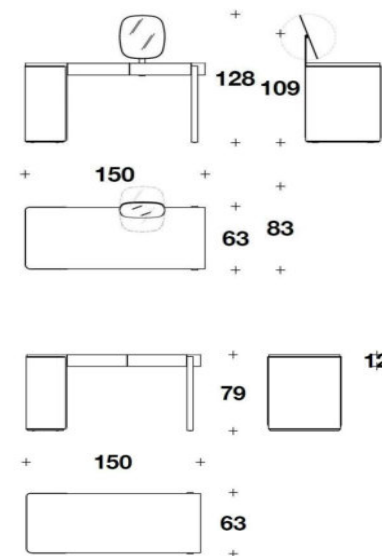



- Innovative layered design combining warm walnut wood with soft beige leather for rich visual depth.

- Unique geometric frame structure providing both aesthetic appeal and practical storage.



73045
Cassettiera destra
Right chest of drawers
cm 39 x 49 x h 50
in 15 3/8 x 19 1/4 x h 19 5/8

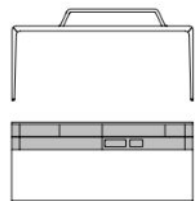

73035
Scrivania
con alzata e LED
*Writing desk
with upper section and LED*
cm 180 x 81 x h 92,2
in 70 7/8 x 31 7/8 x h 36 1/4

CE

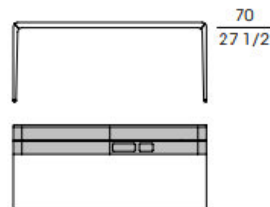

73030
Scrivania
Writing desk
cm 180 x 81 x h 75
in 70 7/8 x 31 7/8 x h 29 1/2

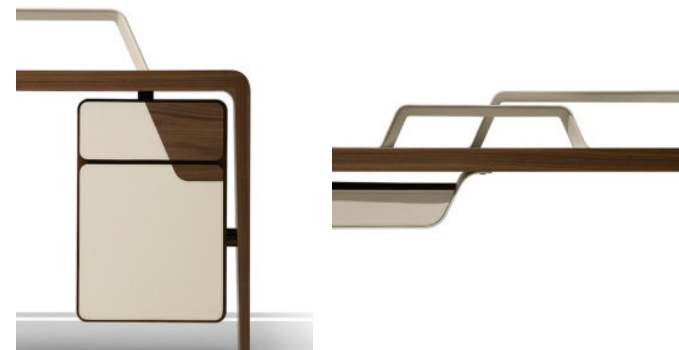



•Unique geometric frame structure providing both aesthetic appeal and practical storage.

•Seamlessly integrated drawer units offering efficient storage solutions.

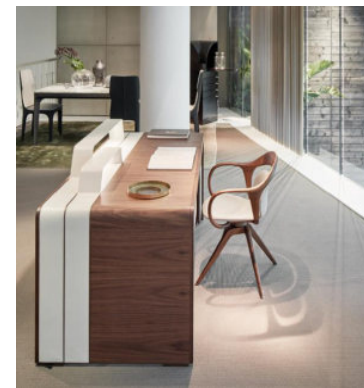



•Integrated multi-socket outlet and dedicated stationery storage blend aesthetic appeal with everyday practicality.

•Robust geometric support structure ensures exceptional stability and durability for a discerning workspace.

•Features a premium white marble top paired with geometric contrast panels in beige and dark brown, creating a modern luxury aesthetic.

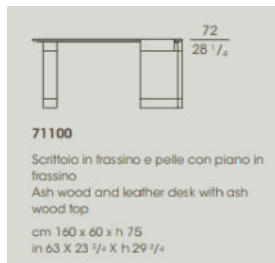
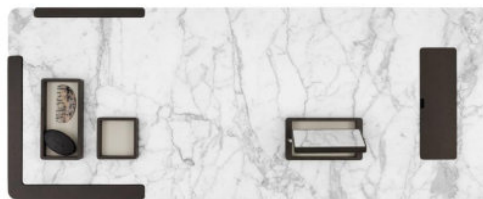

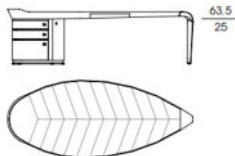

50101
 Scrivania con piano in ebano macassar
 senza passacavo
 Desk top in ebony macassar
 without cable holder
 cm 261.5 x 110 x h 73
 in 103 x 43 3/8 x h 28 3/4

- Crafted from premium solid wood with fluid, organic forms, endowing each piece with unique artistic vitality.
- Offering two distinctive designs—a round conference table and a streamlined executive desk for diverse needs.
- Ingenious structural design ensures exceptional stability and functionality, achieving harmony between art and practicality.



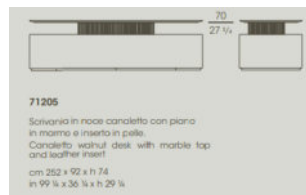

- Innovative modular design with freely combinable units for diverse spaces.
- Premium wood and natural stone top create a composed modern aesthetic.
- Integrated hidden power outlets and metal accents for efficient solutions.

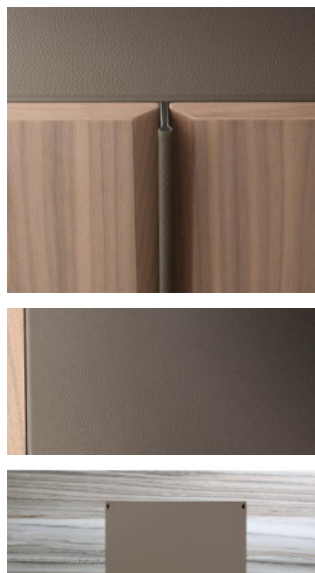

●Integrated hidden power outlets and metal accents for efficient solutions.

●Premium wood and natural stone top create a composed modern aesthetic.



54170
Scrificio
Writing desk
cm 150 x 60.5 X h 78
in 59 x 23 7/8 X h 30 3/4

- Introducing our Luxury Leather & Walnut Writing Desk, a true masterpiece of sophisticated design and material excellence.
- The main image on the left showcases the desk's elegant profile, highlighting the seamless fusion of rich dark brown leather and warm walnut wood. To the right, the detailed views reveal the desk's thoughtful construction: from the hidden storage drawers to the exquisite



craftsmanship visible in the close-up details.

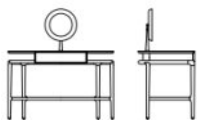

73100
Scrittorio in noce canaletto con specchio,
top pelle
Writing desk in walnut canaletto with mirror,
leather top
cm 120 x 64 x h 126
in 47 1/4 x 25 1/8 x h 49 5/8

- Innovative double-deck top design with grooming space and practical storage, achieving a perfect harmony between functionality and aesthetics.
- Crafted from premium walnut wood and high-grade leather, creating a composed and layered modern home aesthetic.
- Fluid, organic frame structure ensures exceptional stability and durability, perfectly complementing high-end spaces.





- Innovative mixed-material design combining warm walnut wood, soft beige leather, and clear glass for a richly layered aesthetic.

- Thoughtfully designed modular storage system offers flexible organization solutions for high-efficiency office environments.

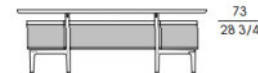

73
28 3/4



53100
Scrivania inserti laterali in pelle
Writing desk, leather lateral inserts
cm 223 x 85 x h 77
in 87 1/8 x 33 1/2 x h 30 3/8

F FENMI CASA Sculptural Dark Wood & Glass Executive Desk

Giorgetti-Office Desk-
SCRIPTOR

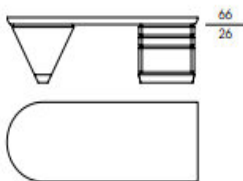

52370
Scrivanica in acero
Writing desk in maple
cm 240 x 90 x h 74
in 94 1/2 x 35 3/8 x h 29 1/8

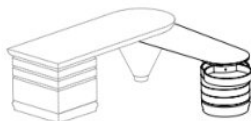

52366 - 52368
Misura massima penisola+scrivanica
Max. size worktop+writing desk
cm 240 x 238 x h 74
in 94 1/2 x 93 3/4 x h 29 1/8

Misura sfruttabile piano penisola
Usable worktop size
cm 157 x 75 + 62 x h 66
in 61 6/8 x 29 1/2 + 24 3/8 x h 26

- Introducing our Sculptural Dark Wood & Glass Executive Desk, a true masterpiece of artistic design and material excellence.
- The main image on the left showcases the desk's striking profile, highlighting the seamless fusion of rich dark wood and clear glass, anchored by unique conical supports. To the right, the detailed views reveal the desk's thoughtful construction: from the intricate cylindrical storage units to the exquisite craftsmanship visible in the close-up details.
- The lifestyle shots demonstrate its seamless integration into contemporary executive offices, while the technical drawings below provide precise specifications. This desk is more than a workspace; it is a statement of sophisticated taste and artistic vision, designed to inspire and elevate any discerning interior.



F FENMI CASA Ergonomic Design Desk

Giorgetti-Office Desk-
SCRIPTOR

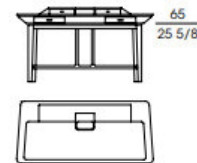

62450
Scrittorio
Writing desk
cm 156 x 70 x h 83
in 61 3/8 x 27 1/2 x h 32 5/8

- A masterpiece of modern design, this executive desk features a robust solid walnut frame exuding natural warmth and durability.
- The premium leather/lacquered top and drawers offer a sophisticated contrast, complemented by meticulously crafted details.
- Designed for both aesthetics and utility, it seamlessly integrates into contemporary office or home environments, embodying a perfect synergy of form and function.

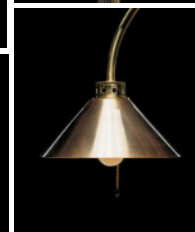
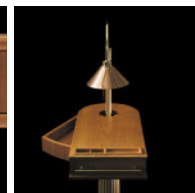
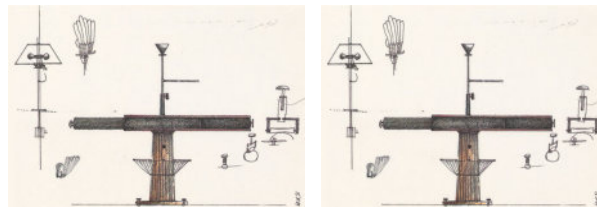

- A stunning revival of Art Deco aesthetics, this exquisitely handcrafted desk marries classical architectural elements with contemporary functionality.
- The iconic fluted column base and integrated brass lamp reflect unparalleled artisanal mastery.

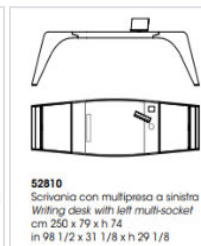
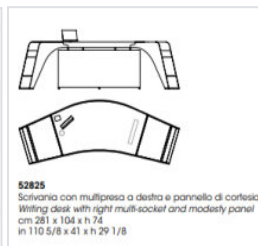
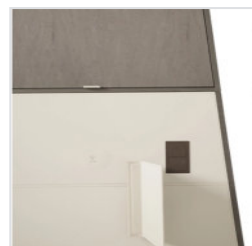

- Where sculptural artistry defines executive presence. This desk features a breathtaking fluid silhouette, crafted from premium grey-stained wood and contrasting composite surfaces.



- Where sculptural artistry defines executive presence. This desk features a breathtaking fluid silhouette, crafted from premium grey-stained wood and contrasting composite surfaces. Its monolithic form exemplifies modern luxury.

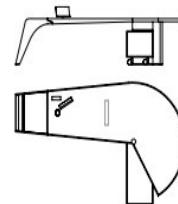

52820
Scrivanica con penisola destra e multipresa
Writing desk with right worktop and multi-socket
cm 318 x 107 x h 74
in 125 1/8 x 77 1/2 x h 29 1/8

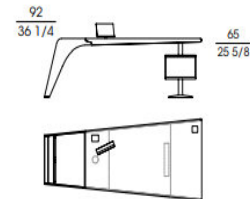

52800
Scrivanica cassetiera destra e multipresa
Writing desk right chest of drawers and multi-socket
cm 230 x 101 x h 74
in 90 1/2 x 39 3/4 x h 29 1/8

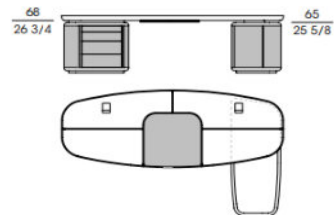

70031

Scrivania con penisola destra inserto centrale e cassetteria in cuoio, inserti e penisola in palissandro
Writing desk with right worktop saddle leather central insert and chest of drawers, rosewood inserts and worktop
cm 270 x 162 x h 74
in 106 1/8 x 63 3/4 x h 29 1/8

- Epitomizing timeless luxury, this executive desk seamlessly blends classic design principles with contemporary craftsmanship.
- The rich, dark leather is masterfully paired with premium light wood and metallic accents, highlighted by exquisitely rounded contours and symmetrical cabinetry.



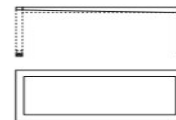

51387
 Scrivania in faggio piano laccato in gomma liquida
 Writing desk in beech wood, liquid rubber lacquered top
 cm 200 x 80 x h 73,5
 in 78 3/4 x 31 1/2 x h 29

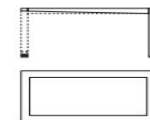

51384
 Scrivania in faggio piano laccato in gomma liquida
 Writing desk in beech wood, liquid rubber lacquered top
 cm 160 x 80 x h 73,5
 in 63 x 31 1/2 x h 29



- Now presenting the 'Minimalist Geometric Desk'. It is the perfect embodiment of minimalist design, elevating the pure beauty of geometric forms and structural stability to their ultimate expression.

- Whether in the deep, grounded tones of the dark finish or the warm, inviting hues of the light option, its clean lines and pure materials seamlessly integrate into any modern minimalist space.

- Notice how the signature Z-shaped support not only gives it distinctive visual support but also showcases the perfect fusion of mechanics and aesthetics.



- An exercise in refined minimalism, this console embodies the essence of contemporary living.

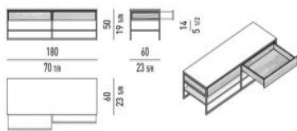

Misura interna cassetti / Drawers internal size:
cm 82x41 h7,5

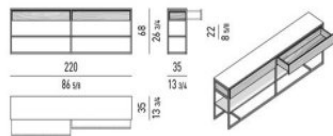

Misura interna cassetti / Drawers internal size:
cm 102x26 h7,5



- Its slender metal frame and contrasting dark wood top create a striking visual dialogue, while the layered open storage offers both functionality and sophisticated display options.



- Supreme Material Quality
Luxurious finishes with premium marble and exotic wood veneers.
- Architectural Metal Frame
Slender polished frame creates an airy, floating aesthetic.
- Layered Functional Design
Multiple tiers offer generous storage without compromising silhouette.



WOODEN TOP

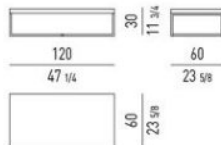
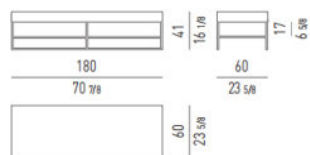

WOODEN TOP

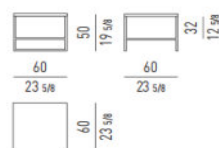
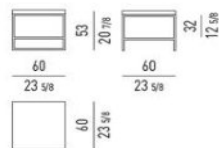

- Supreme Material Quality
Luxurious finishes with premium marble and exotic wood veneers.
- Architectural Metal Frame
Slender polished frame creates an airy, floating aesthetic.
- Timeless Sophistication
Merges natural warmth with industrial coolness for enduring style.

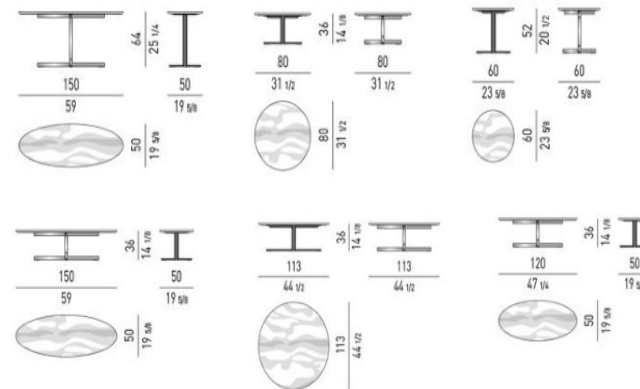

- Sculptural Silhouette : Elegant oval shape creates a timeless focal point.
- Harmonious Proportion: Balanced dimensions complement various seating arrangements.

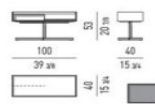

Vassio | Tray: cm 68x38 h2,5
Dimensione interna | Internal size: cm 44x35 h1

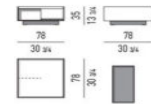

Vassio | Tray: cm 35x73 h2,5
Dimensione interna | Internal size: cm 32x70 h1

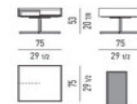

Vassio | Tray: cm 35x73 h2,5
Dimensione interna | Internal size: cm 32x70 h1

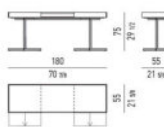
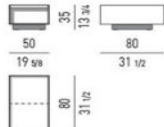
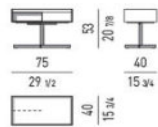

con due cassetti
with two drawers

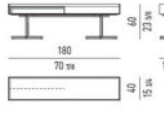
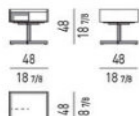
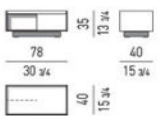

- Sophisticated tactile experience with understated luxury. Sturdy Metal Base.
- Robust dark bronze base adds industrial elegance. Luxury Integration





- **Sophisticated Textured Surface**
Premium tactile experience with a dark, finely textured top.
- **Luxury Integration**
Seamlessly blends into high-end contemporary interiors.



- Refined Metal Base
Slender dark bronze frame offering robust support and industrial elegance.

- Sturdy Metal Base
Robust dark bronze base adds industrial elegance.



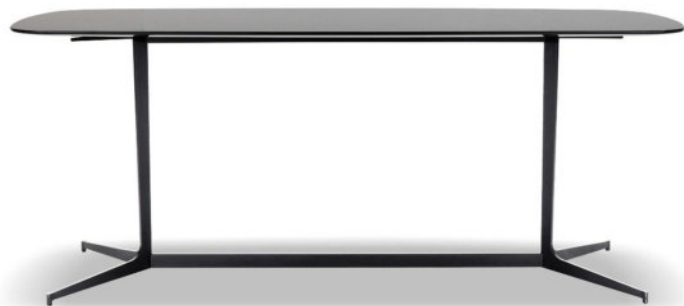

- Premium Craftsmanship & Versatile Design
Meticulously engineered connections highlight exceptional build quality. Seamlessly integrates into contemporary interiors from lofts to urban apartments.

- Distinctive Y-Shaped Base & Sleek Oval Top
Features a sculptural metal base for stability and modern aesthetic. The premium black oval tabletop offers a sophisticated surface for everyday use.

GLASS TOP

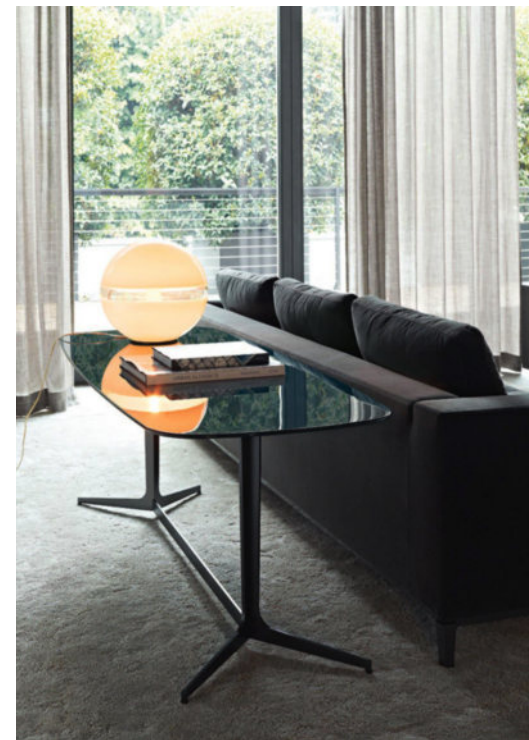
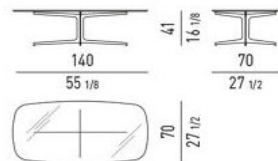

FENMI CASA Luxury Material Fusion Desk



Copyright Minotti SpA

- Premium Craftsmanship & Versatile Design
Meticulously engineered connections highlight exceptional build quality. Seamlessly integrates into contemporary interiors from lofts to urban apartments.
- Bold Geometric Silhouette: Clean linear forms for a powerful modern aesthetic.
- Luxury Space Compatibility : Seamlessly integrates into high-end contemporary interiors.

Minotti-Office Desk-Diagramma Writing Desk

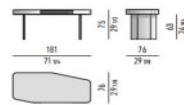

MISURE INTERNE | INTERNAL MEASUREMENTS

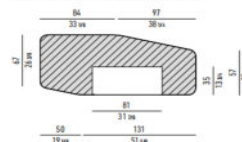

DIMENSIONE VANO INTERNO | INNER COMPARTMENT DIMENSION:
CM81X35 HB



Copyright Minotti SpA

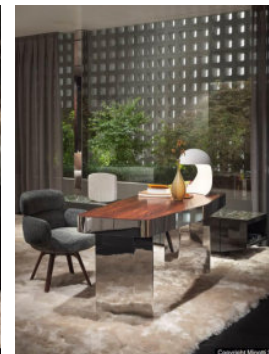

Copyright Minotti SpA



FENMI CASA Urban Luxury Writing Desk

Minotti-Office Desk-Jacob Writing Desk

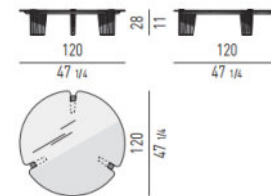

Disponibile solo con piano vetro e sucupira
Available only with top in glass and sucupira

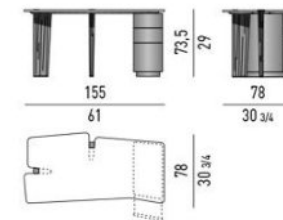

- Integrated Storage
Seamless cabinet with ample discreet storage.
- Premium Finish
Dark textured surface for sophisticated luxury.
- Geometric Base
Robust structure with architectural stability.
- Urban Integration
Blends modern function with urban elegance.



- **Minimalist Linear Form**
Clean, uncluttered linear profiles create a timeless aesthetic.
- **Versatile Space Compatibility**
Functions seamlessly as both a bench and a coffee table.

- **Diverse Material Options**
Choice between luxurious dark marble and warm wood-textured finishes.
- **Sculptural Tapered Legs**
Elegantly tapered legs provide robust support with a unique sculptural element.

GLOSSY VARNISHED TOP

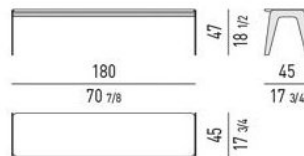

GLOSSY VARNISHED TOP

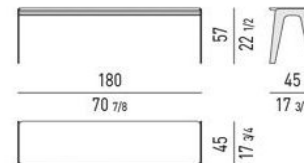



- Distinctive Material Fusion
Rich wood grain combined with polished metallic accents.
- Bold Geometric Silhouette
Clean linear forms for a powerful modern aesthetic.

- Exquisite Craftsmanship
Meticulously engineered joinery and seamless transitions.
- Luxury Space Compatibility
Seamlessly integrates into high-end contemporary interiors.

HIGH CONSOLE

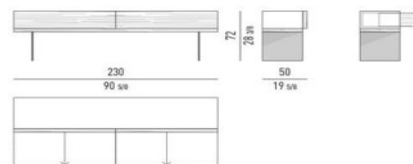

LOW CONSOLE

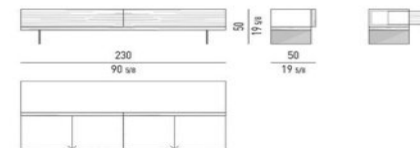



- Premium Wood Veneer
Rich dark-stained wood with sophisticated grain pattern.
- Geometric Metal Structure
Robust angular frame for exceptional stability.

- Clever Storage Design
Minimalist integrated drawers for essentials.
- Luxury Integration
Blends natural warmth with industrial coolness.

WRITING DESK CM 200X75 WITH VALET TRAY

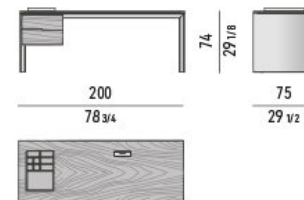

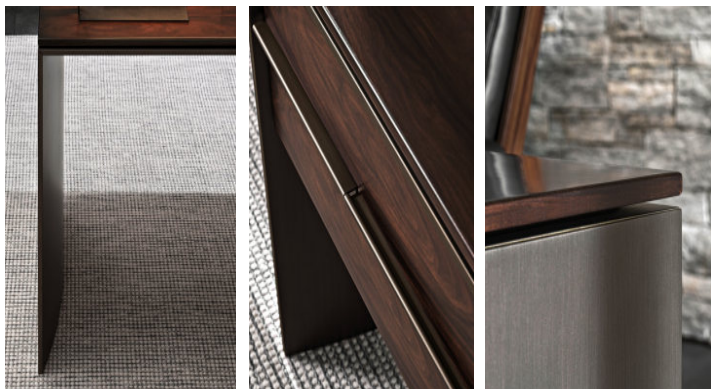

WRITING DESK CM 180X65

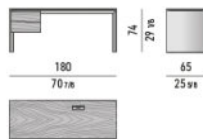

WRITING DESK CM 250X110 WITH VALET TRAY

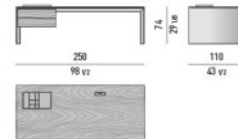

WRITING DESK CM 180X65 WITH VALET TRAY

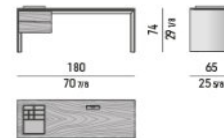

- This desk combines the smoothness of natural wood with the coldness of industrial metal, making it an ideal choice for enhancing the style and functionality of executive office spaces.



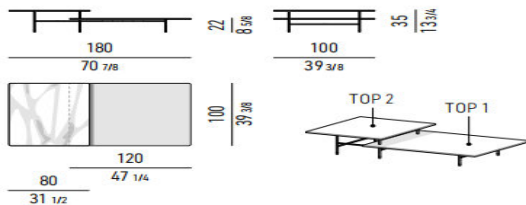

- Diverse Materials & Luxury Integration
Rich wood, luxurious marble, and sleek lacquer options seamlessly complement high-end contemporary interiors.
- Lightweight Metal Frame & Minimalist Design
Exceptionally slender frame for an airy aesthetic; clean, unadorned tabletops embodying pure minimalist elegance.



- Concealed Storage Design:
Handle-less drawers for a clean, uncluttered silhouette.
- Versatile Space Compatibility:
Perfect as a console or TV stand in contemporary interiors.



LACQUERED VERSION

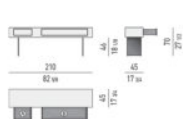

SPAZIO UTILE INTERNO CASSETTO (A) CM 41,5K32 H15
DRAWER (A) INTERNAL DIMENSION: CM 41,5K32 H15

SPAZIO UTILE INTERNO CASSETTO (B) CM 111,5K32,5 H15
DRAWER (B) INTERNAL DIMENSION: CM 111,5K32,5 H15

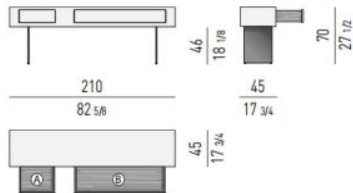

- Luxurious Leather Finish:
Sumptuous surface with exceptional tactile experience.
- Minimalist Metal Base:
Slender polished legs for modern elegance and support.

FENMI CASA Contrast Material Console Desk

NATUZZI ITALIA-Office Desk-
Filrouge



- **Contrasting Material Design**
Combines cool white marble with warm dark wood for a striking visual dialogue.
- **Geometric Metal Frame**
Slender matte black frame with clean lines for a bold modern aesthetic.

- **Minimalist Linear Aesthetic**
Uncluttered silhouette with precise proportions, embodying contemporary minimalism.
- **Practical Storage Function**
Integrated drawer offers convenient storage without compromising design.



- Natural Wood Aesthetic: Warmth and organic beauty from light-toned solid wood.
- Minimalist Linear Design: Clean lines embodying contemporary minimalist principles.
- Soft Rounded Form: Gentle edges add elegance and enhanced safety.
- Versatile Space Adaptability: Seamlessly integrates into offices or cozy living areas.





- Minimalist Linear Design: Clean lines embodying contemporary minimalist principles.

- Distinctive asymmetrical tabletop with contrasting panels for a bold visual statement.

- Clean lines and refined silhouette embody contemporary minimalist design.



- **Minimalist Linear Design:**Clean lines and refined silhouette embodying contemporary minimalist principles.
- **Black Metallic Aesthetic:**Sleek all-black construction exuding modern sophistication and industrial elegance.





- Wood & Glass Fusion
Combines rich dark-stained wood with sleek glass for airy sophistication.
- Practical Storage Design
Integrated right-side cabinet offers discreet storage without disrupting clean lines.
- Modern Luxury Aesthetic
Refined silhouette and premium materials embody contemporary executive design.



- Curved Tabletop Aesthetic: Organic curved design softens the workspace, enhancing ergonomics.
- Dark Wood Veneer : Rich, dark-stained wood veneer with a refined grain for luxurious appeal.
- Mixed Support Design: Polished metallic legs for a modern industrial look or solid wood legs.



- Geometric Frame Aesthetic
Bold angular structure with architectural presence.
- Mixed Material Design
Rich wood veneers with smooth leather inlays.
- Practical Leather Inlay
Precisely cut surface for writing and laptops.

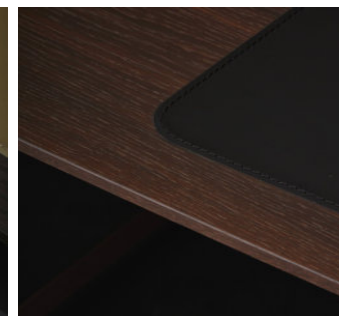
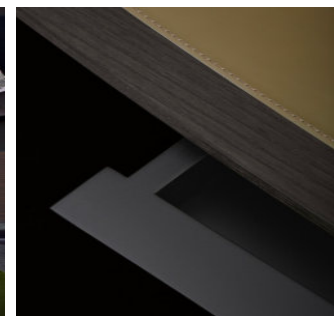
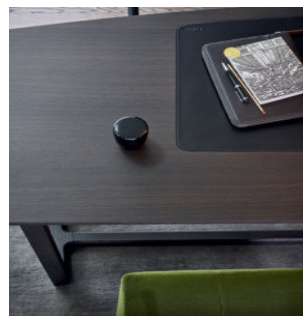



- Practical Leather Inlay
Precisely cut surface for writing and laptops.
- Modern Study Integration
Seamlessly fits contemporary environments.

- Geometric Frame Aesthetic
Bold angular structure with architectural presence.
- Mixed Material Design
Rich wood veneers with smooth leather inlays.





- **Dark Wood Aesthetic**
Rich solid wood construction with timeless elegance.
- **Minimalist Structure**
Clean geometric frame embodying contemporary design.
- **Concealed Storage**
Sleek handle-less drawers for uncluttered storage.



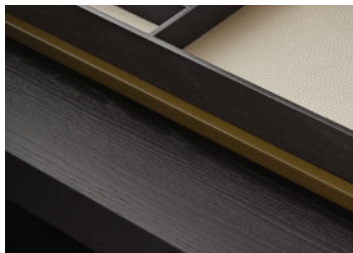

- **Concealed Storage**
Sleek handle-less drawers for uncluttered storage.
- **Space Adaptability**
Versatile fit for study, entryway or living room.
- **Minimalist Structure**
Clean geometric frame embodying contemporary design.





- Aesthetic Design: Soft-edged oval top for ergonomic workspace.
- Metallic Structure: Matte black frame with industrial elegance.



F FENMI CASA Oval Top Modern Desk

Poliform-Office Desk-MATHIEU



- Premium Surface
Smooth, refined texture
for luxury feel.



- Urban Integration
Perfect for high-rise
contemporary spaces.



FENMI CASA Oval Top Modern Desk

Porada-Office Desk-Flavio

- Classic & Modern
Seamlessly integrates classic warmth with contemporary design elements.

- Practical Zoning
Thoughtfully designed dedicated zones enhance workspace efficiency and organization.



- Abundant Storage
Discreetly integrated drawers offer organized storage without compromising the refined silhouette.

- Material Fusion
Warm walnut wood meets sophisticated light-toned material for a luxurious tactile experience.

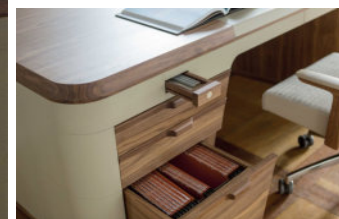

F FENMI CASA Walnut & Metal Executive Desk

Porada-Office Desk-Kepler

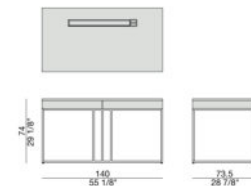
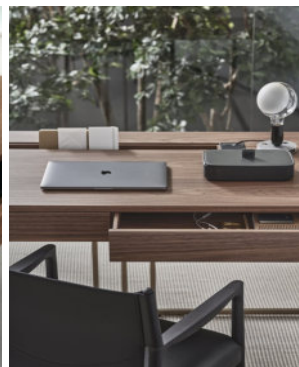

- Walnut Wood Aesthetic: Rich, warm walnut veneer with a refined grain pattern delivers a luxurious tactile experience.

- Practical Storage Function: Sleek, handle-less drawers offer ample storage without disrupting the streamlined look.





- Features a uniquely integrated mirror that seamlessly folds into the tabletop, offering a dedicated vanity space without compromising clean lines.

- Material Fusion Aesthetic: Combines warm walnut wood with a sophisticated light-toned material, creating a harmonious visual dialogue and luxurious tactile

- Includes discreetly integrated drawers and compartments for organized storage of cosmetics and accessories, maintaining a clutter-free environment.

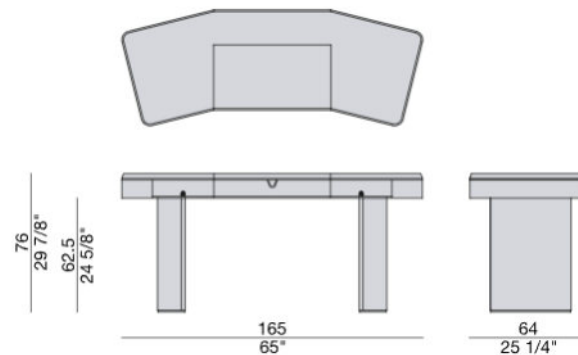

FENMI CASA



FENMI

分米

